

Medentika[®] Prosthetic Solutions

DIGITAL WORKFLOW COMPONENTS



DENTAL EXCELLENCE WITH MEDENTiKA® DIGITAL WORKFLOW COMPONENTS

WELCOME TO THE FUTURE OF DENTISTRY

As pioneers in digital dentistry, we are dedicated to transforming how dental care is delivered and experienced.

With our cutting-edge technology and innovative solutions, we empower dental professionals to achieve greater precision, efficiency and patient satisfaction.

Whether you're seeking to streamline workflows, enhance treatment outcomes, or elevate the patient experience, Medentika is your trusted partner every step of the way with our Digital Workflow Components.

Join us on a journey beyond traditional dentistry and discover the limitless possibilities of digital innovation for transforming smiles and lives.



Efficiency

One digital workflow for over 100 implant connections



Flexibility

A comprehensive prosthetic portfolio to meet every need



Integrity

Constantly updated and accessible CAD/CAM libraries



Trust

Experience lifetime trust in German high-precision engineering and 20 years of expertise

BOOSTING PRECISION AND
PATIENT SATISFACTION.
WITH MEDENTIKA[®], CONFIDENTLY
DELIVER TOP-QUALITY CARE.

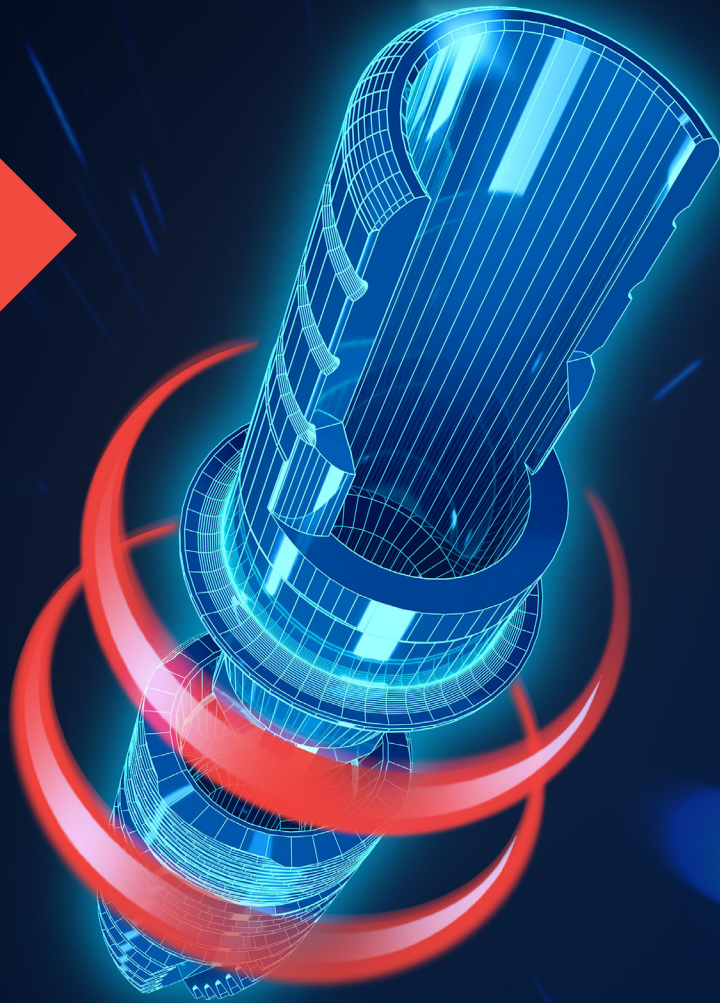

THE DIGITAL WORKFLOW FOR YOUR SUCCESS

Medentika® Implant Systems and Prosthetic Solutions are included in all major planning software.



SCANBODIES



Implant Level



Abutment Level



Novaloc® / MedentiLOC™



RevEX®



MedentiWings

Medentika® Implant Systems and Prosthetic Solutions are included in all major design software.

PLAN



SCAN



DESIGN



coDiagnostiX®

exocad

3shape

PLANMECA

smop
powered by swissmeda

Dentsply
Sirona

Carestream
DENTAL

Zirkonzahn
Human Zirconium Technology

blenderfordental

... and many more



Intraoral Scanners



Lab Scanners

AMANNGIRRBACH

exocad

3shape

PROMADENT
Quality Dentalware

hypsoCAD

dental wings
A Straumann Group Brand

blenderfordental

CARES® Visual

... and many more

LABORATORY IMPLANTS



CADCAM-CS



Multi-unit / MedentiBASE



Novaloc® / MedentiLOC™

STOCK ABUTMENTS



Titanium Base ASC Flex



Titanium Base 2nd generation



Titanium Base SSC Flex



Multi-unit / MedentiBASE



Novaloc® / MedentiLOC™

CENTRALIZED MILLING



Custom Abutment



Custom Abutment AS

LOCAL MILLING



PreFace Abutments



TI-Forms Abutments

MODEL



FINAL PROSTHESIS



3-D Printing

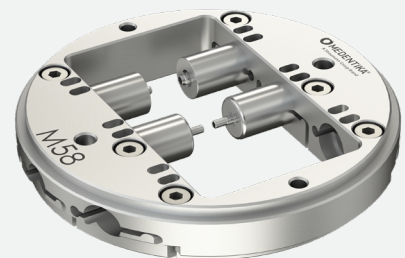

... and many more



DIGITAL WORKFLOW COMPONENTS AT A GLANCE



SCANBODIES

ENHANCED SCANNING FOR PROSTHETIC PRECISION

Our titanium Scanbodies are compatible with both chairside and lab scanners, ensuring exceptional precision and durability.

The special non-reflective surface treatment eliminates the need for scan spray or powder, while laser marking clearly indicates implant compatibility for easy and accurate identification.

These new metal Scanbodies provide efficient and precise performance, appealing to dental professionals seeking streamlined workflows.

NEW IMPROVED SCANBODY-DESIGN

Reduced Diameter

Giving more space to adjacent teeth

Higher Body

More visible parts for the scanner

Radio Opacity

Easy visibility for x-ray inspection

Prolonged Part

For managing the emergence profile (hard- and soft-tissue)



Rounded Edges

Supporting scan-precision in CAD software

Reusable and Sterilizable

Opportunity to use in multiple scans since it can be sterilized

Tapered/Contoured Design*

For management of the emergence profile (reduced pressure on soft-tissue, limited impact on hard-tissue, in case of bone overgrowth allowing correct end position inside of the implant)

*This part of the Scanbody may vary slightly from Series to Series to match the individual Implant.



MEDENTIWINGS

SIMPLIFYING EDENTULOUS SCANNING

Traditional intra-oral scanners struggle with large gaps between Scanbodies, leading to inaccurate stitching and potential restoration misfit. MedentiWings addresses this challenge!

These innovative products attach to our new generation Scanbodies*, enabling more reliable scanning for clinical cases with wide distance between Scanbodies, specially in full-arch edentulous cases.

They offer several key advantages:



Full Digital Workflow

Maintaining a cost-efficient digital workflow with full flexibility.



Cost-effective

Utilized with new Medentika metal Scanbodies, no additional products required.



Improved Accuracy

Designed to ensure accurate stitching for optimal restoration fit.



Versatility

Available in five configurations to best match the individual clinical patient situation.



Customization

Adaptable for specific needs.

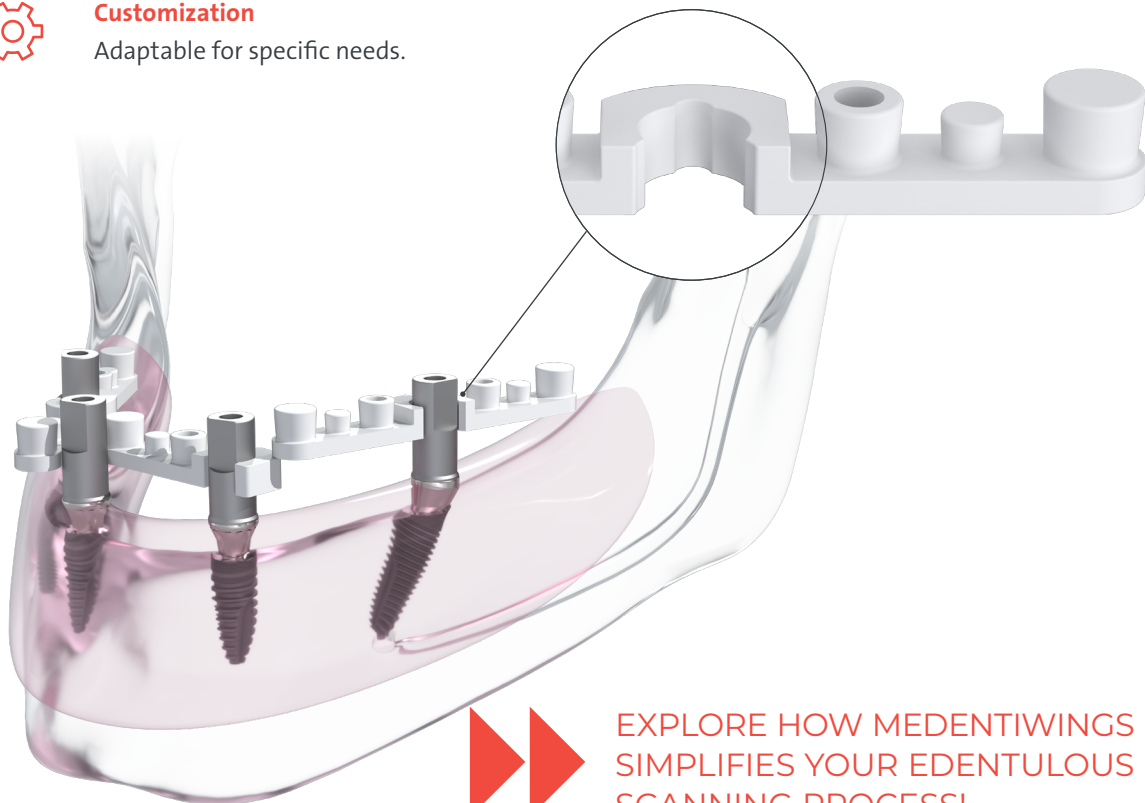

EXPLORE HOW MEDENTIWINGS SIMPLIFIES YOUR EDENTULOUS SCANNING PROCESS!



Click or scan the code for more details

*For each Scanbody/scanpost used, please ensure you select and utilize the corresponding digital library to guarantee accurate and successful outcomes.

NOVALOC® / MEDENTILOC™ DIGITAL

DIGITAL PRECISION FOR REMOVABLE PROSTHETICS

Novaloc® / MedentiLOC™ Digital represents our innovation that advances removable prosthetics into the digital era of dentistry.

This fully digital workflow includes Scanbodies for the Novaloc® and MedentiLOC™ Abutments, sterilizable titanium Repositional Analog, and Retention Screws all designed for precision and efficiency.

With the library available for 3Shape and exocad, it simplifies data storage and sharing, eliminates conventional impression materials, and reduces patient visits. Novaloc® / MedentiLOC™ Digital is a versatile, indispensable tool for modern dental practices and is compatible with major Intra-oral Scanning systems and designed for ease of scanning.



ABUTMENT LEVEL WORKFLOW



ABUTMENT LEVEL WORKFLOW WITH PRINTED MODEL





REVEX SCANBODY

DIGITALIZE YOUR FULL-ARCH RESTORATIONS

Streamline your workflow with the RevEX Scanbody for precise full-arch restorations.

This innovative solution enables external scanning of temporary prosthetics and the corresponding digital bite transmission, eliminating the need for traditional impression and bite registration process.

3 VISITS INSTEAD OF 5

1ST VISIT



Digital Impression

2ND VISIT



Milled prototype
and verification jig try-in

3RD VISIT



Delivery

Go Digital

Effortless transition to digital impressions with minimal steps.

Save Time

Reduce treatment time with RevEX (3 visits vs. 5).

Enhanced Comfort

Eliminate bulky impression trays for a more comfortable patient experience.

Cost-effective

Save time and reduce expenses with RevEX – fewer visits and no extra equipment needed.

Seamless Integration

Works with your existing scanners – no additional devices required.

Durable Scanbodies

Metal RevEX Scanbodies offer long-lasting reusability.



CADCAM-CS LABORATORY IMPLANTS

DISCOVER WHAT'S NEXT

Expertly crafted for seamless integration into your digital workflow, our new CAD/CAM laboratory implants feature a precision-engineered bottom screw for accurate and stable positioning within models. Once inserted, the laboratory implants remain firmly in place, eliminating the need for adjustments.

In addition, they incorporate the "click" function, providing customers a dual security system.



Efficiency

Simplified stock management for seamless operations.



Precision

Ensures precise positioning and minimizes micro-movements.



Flexibility

Featuring the bottom screwing and click function.



Color coded and laser marked for easy identification

Made from titanium Grade 5

"Click" feature

Compact size to prevent collisions with adjacent laboratory implants

One counter screw and one screw driver for all the series



TITANIUM BASE ASC FLEX

PRECISION ENGINEERING FOR ESTHETICALLY CHALLENGING PROSTHETIC CASES

This cutting-edge design is meticulously crafted for angulated screw channels, tailored to meet your demanding needs in esthetically challenging prosthetic cases.

Rotating and non-rotating option available*

ASC: Angled Screw Channel

6.5 mm

5.5 mm

4.5 mm

3.5 mm

Customizable Chimney Height

While the chimney height of 6.5 mm also supports high restorations, it can be shortened in individual cases to 5.5, 4.5, 3.5 mm adapting to every clinical situation.

Screw Channel

Compatible with both angled and straight screw channels.

Gingival Height

Available in 1.0 mm and 2.5 mm for more flexibility.

Optimized Emergence Profile

The optimized emergence profile supports and protects the soft tissue.

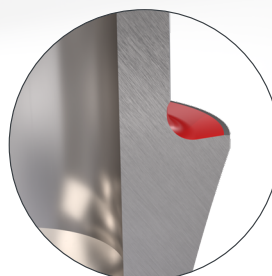

Ball Torx Placement Instrument

Allows angulation of up to 25°. Ensures easy and reliable tightening.



Slightly Tapered Shoulder Design

Slightly tapered platform to hold the fixing material, thereby reducing the bonding gap in the transitional area to the gingiva.

*Not all products are available in all series. Please check our catalog for more information.

TITANIUM BASE SSC FLEX

VERSATILE SOLUTIONS FOR ENHANCED DENTAL RESTORATIONS

Introducing the new Titanium Base SSC Flex: Enhanced flexibility for single and bridge restorations, available in engaging and rotating versions. Its innovative design provides more options for gingiva height and a higher cuttable chimney for customization. With original screw heads and compatibility with major implant connections, the Titanium Base SSC Flex sets a new standard in dental restoration.

SSC: Straight Screw Channel

▶▶ NEW IN 2025

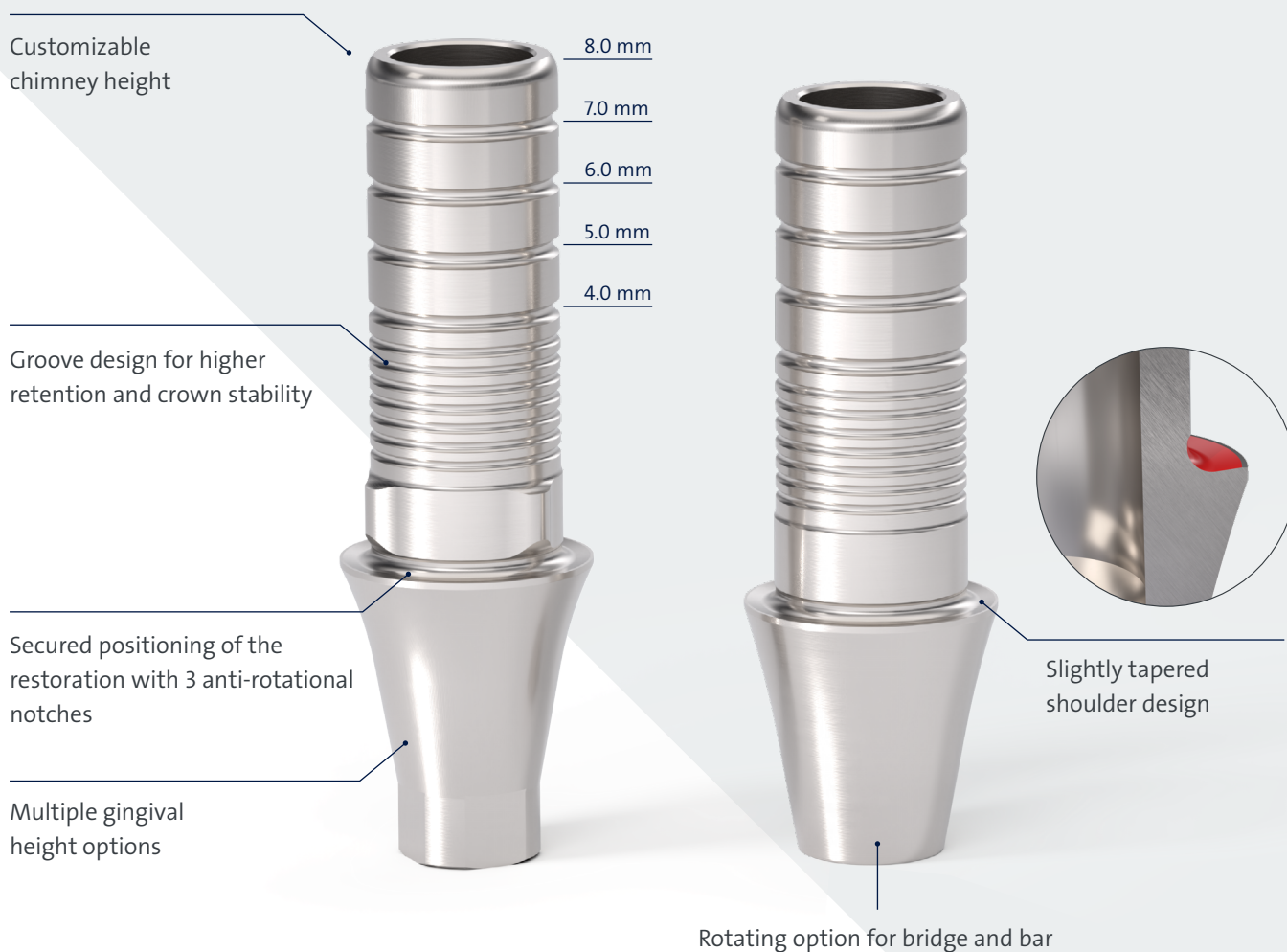



TITANIUM BASE SSC FLEX MOLAR

▶▶ NEW IN 2025

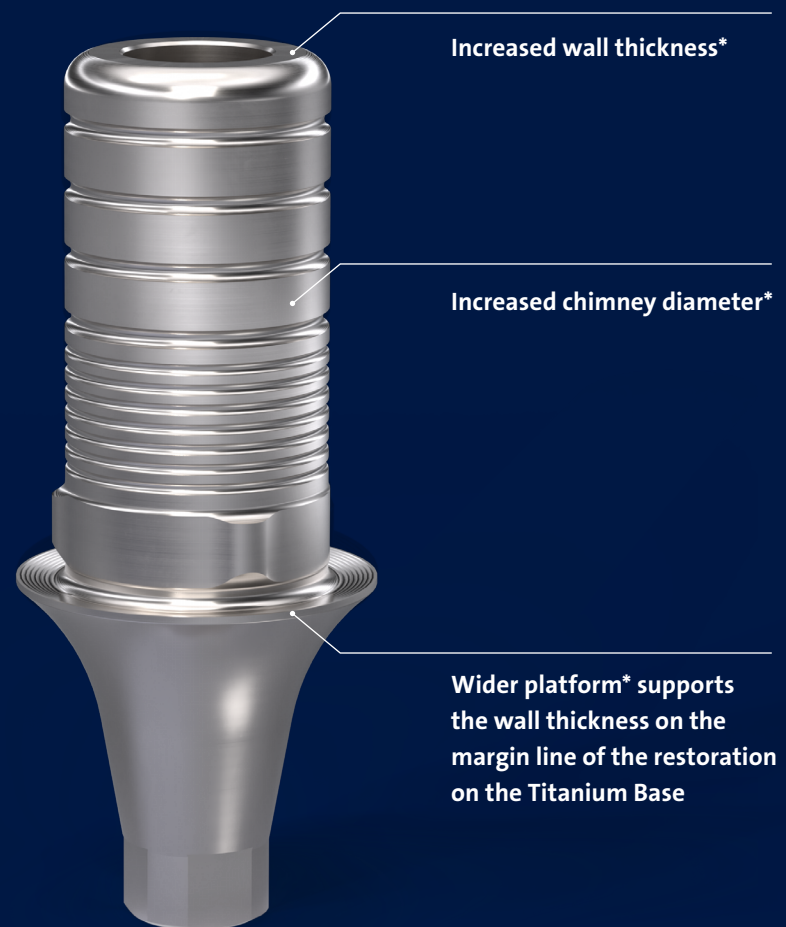

THE SSC FLEX MOLAR IS SPECIFICALLY DESIGNED FOR LARGE MOLAR CROWNS.

*Compared to our Titanium Base SSC Flex

PREFACE ABUTMENTS & HOLDERS

ELEVATE YOUR PRACTICE WITH IN-HOUSE ABUTMENT PRECISION

PreFace Abutments offer exceptional design flexibility and precision, reducing machining times with two diameter options for optimal efficiency.



THE MEDENTiKA® PREFACE LINE EMPOWERS YOU TO TAKE CONTROL AND LAUNCH YOUR OWN IN-HOUSE ABUTMENT PRODUCTION.

EXPERIENCE VERSATILITY AND PRECISION WITH MEDENTiKA® PREFACE ABUTMENTS:



Maximum Design Freedom

Choose from two convenient blank diameters (11.5 mm and 16 mm) to create a wide range of customized abutment solutions.



Simplified Design

The special design allows for easy emergence profile customization, catering to your specific needs.



Precision of Connection

Prefabricated, high precision implant-abutment connection with Medentika guarantee.



Available Materials

Select from biocompatible Titanium or CoCr to meet your individual requirements.



ELEVATE YOUR PRODUCTION WITH PREFACE ABUTMENT HOLDERS

The innovative single-piece design of PreFace Abutment Holders is designed to ensure high precision. These holders offer a multitude of benefits:



Streamlined Workflow

Simultaneously machine up to six blanks in a single process for exceptional time savings.



Minimal Components

A simple design with fewer parts minimizes production errors and reduces costs.



Simplified Abutment Attachment

Secure the abutment with just one screw for a fast and efficient workflow.



Cost-effective Investment

The straightforward design eliminates the need for expensive wearing parts, making PreFace Abutment Holders an attractive investment.



Enhanced Protection

Similar to PreFace Abutments, the holder design safeguards the implant interface during tightening.

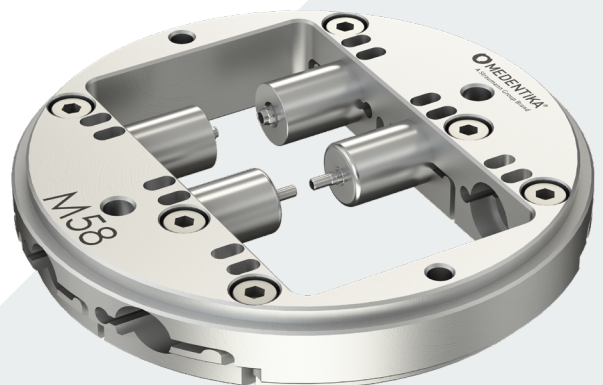

THE MEDENTiKA® PREFACE LINE –
CRAFTED WITH PRECISION AND
INNOVATION.
UNLOCK A WORLD OF POSSIBILITIES
AND ELEVATE YOUR IMPLANT
PRODUCTION TO NEW HEIGHTS.

MULTI-UNIT ABUTMENTS

VERSATILE SOLUTIONS FOR COMPLEX PROSTHETIC CONFIGURATIONS

Our Multi-unit Abutments are engineered for versatility, offering various angulations and gingival heights to correct implant alignment, ensuring precise positioning and stability of the prosthesis.

They provide robust support, evenly distributing occlusal forces across multiple implants for superior long-term success.

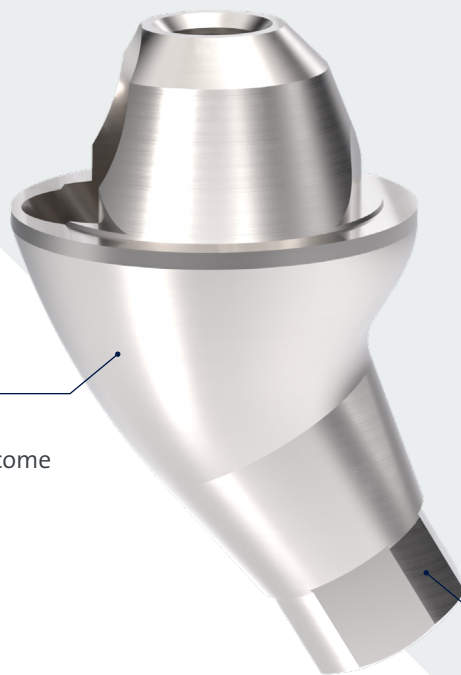
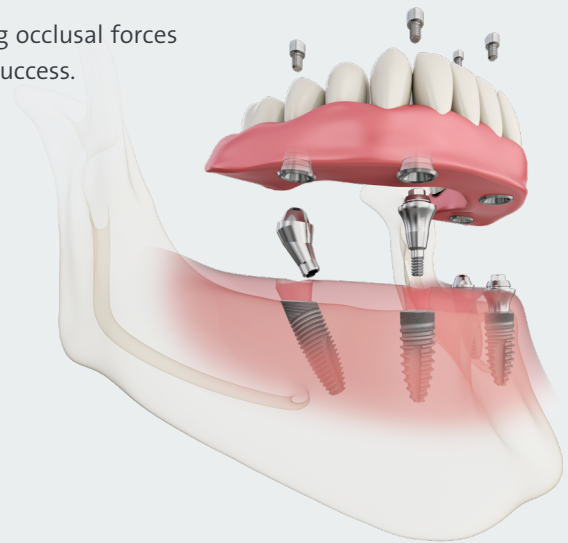

Treatment Options

Various prosthetic components are available for the different treatment options.



THE MULTI-UNIT ABUTMENTS ARE AVAILABLE WITH TWO ANGULATIONS: 17° AND 30°.

Gingival Height

The Multi-unit Abutments come in various gingival heights.

Implant Connection

Compatible with the implant connections from the major implant manufacturers.



PLACEMENT INSTRUMENT

The supplied bridge screw incorporates the proven slot for the Ball-Torx placement instrument M 03-8, M 10-8 or 6-13-06.

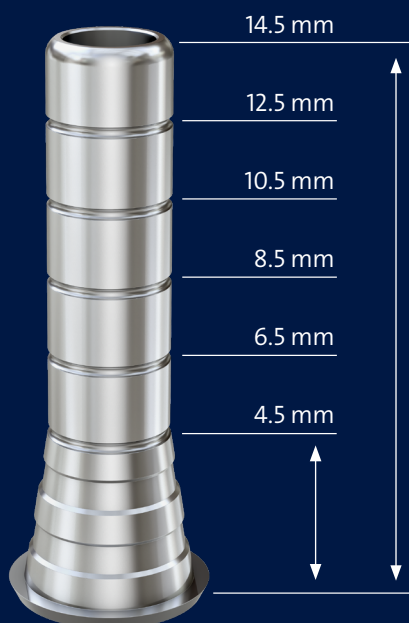

TITANIUM CAP FLEX

The titanium cap Flex offers a variable chimney height. The 14.5 mm chimney height also supports high restorations, whether for a provisional or definitive restoration. However, this can be individually shortened in 2 mm increments to 4.5 mm. The different chimney heights are defined in the CAD library.

TITANIUM BASE STRAIGHT AND ASC

For unfavorably positioned implants or in an esthetically demanding site, the screw channel can optionally be moved to the non-visible area.



SCANBODY

Multi-unit Scanbody for taking impressions of straight and angled Multi-Unit Abutments.



LABORATORY IMPLANT CADCAM-CS

For use in digital model fabrication (printed models).



RE-ENGINEERED COMPATIBLE PROSTHETICS.



© MEDENTiKA® GmbH, 2024. All rights reserved.
MEDENTiKA® and/or other trademarks and logos from MEDENTiKA® mentioned herein
are the trademarks or registered trademarks of MEDENTiKA® GmbH and/or its affiliates.
Please note that this brochure contains images created by AI.

PM02_01_0067/EN 10/24

MEDENTiKA® GmbH
Hammweg 8–10
76549 Hügelsheim
Germany
info@medentika.de
www.medentika.com

